

Series EE 8000

Intercom stations for industry and infrastructure



Audio +
functionality

Weather-
proof
IP66

Rugged
housing

Modular
construction

Optimised for harsh environments and challenging situations

Series EE 8000 Intercom stations are designed specifically to withstand extreme temperatures, moisture and dirt, and provide clearly intelligible audio communication – even in areas with extreme ambient noise. This way, they contribute significantly to enhanced safety and smooth workflows in various and extreme applications.

Focused on maximum reliability, easy operation and high scalability, the robust hardware is controlled by flexible, site-configurable software with functions and features that provide exactly what the user and local regulations require.

The products of the Series EE 8000 are used successfully in numerous projects and industrial applications such as metal and mining, manufacturing industry, oil and gas, chemical industry or energy and public utilities. Because of their useful qualities, the Intercom stations are also installed in ports, waterways, tunnels and highways.

Key benefits at a glance

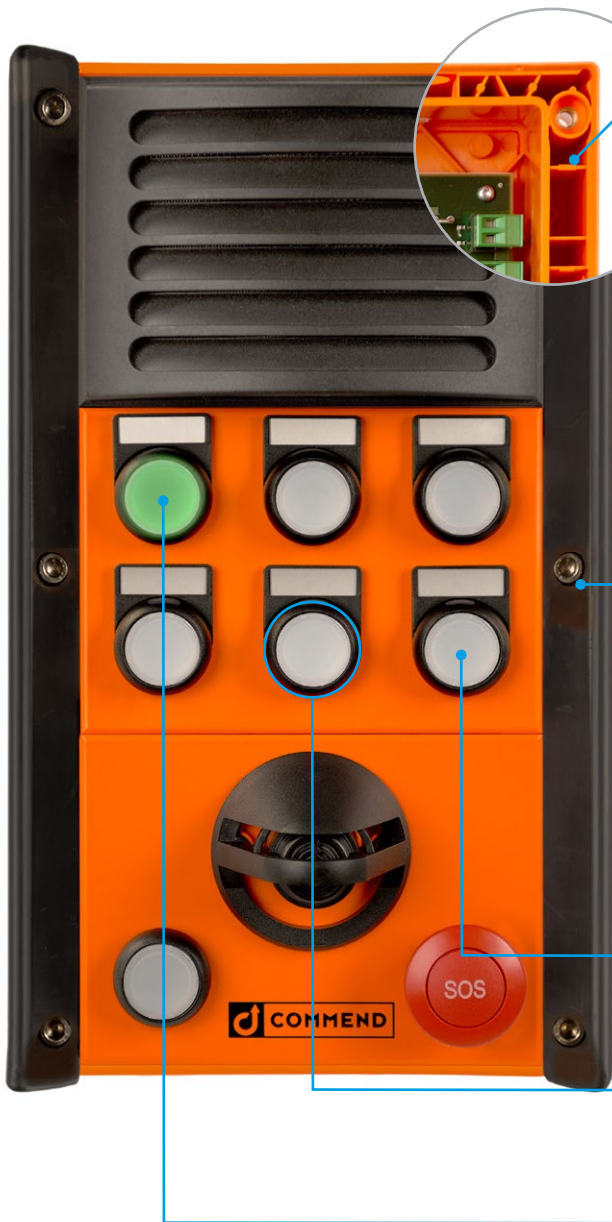

Housing: robust, durable, easily visible

Protected against mechanical damage

Double-walled, strut reinforced basic housing ensures ultimate stability, impact resistance and ingress protection. In the unlikely event that the outer shell is damaged by extreme force, the components inside the inner shell remain protected against ingress of dust or water.

Resistant against chemical and weather-related influences

Weather-proof, corrosion-resistant plastic and an inner silicone-free, foamed sealing ensure resistance against chemical substances and high temperatures. The housing is coated with a special industrial varnish to prevent material deterioration. This coating also provides a high level of resistance against UV radiation and flame retardancy as per UL 94v0.

Protected against ingress of water jets and dust

Thanks to its compact, sturdy construction, the device is IP66-rated. As a result, the housing is fully protected on all sides against the ingress of dust or strong water jets.

Side impact protection for control elements

Two impact protection strips help to prevent damage to the active and passive control elements. The extra high protection efficiency is achieved through a two-component construction technology using thermoplastic elastomer compounds (for shock absorption) and a honeycomb structured polyamide core.

Easily visible in any environment

An eye-catching bright orange colour finish ensures that the station is easy to find, especially in emergency situations.

Operation: easy, clearly structured, multi-functional

Easy to operate

Large industrial-sized buttons enable quick, targeted access to all essential functions. The buttons are designed to be easily to operate even when wearing work gloves.

Protected buttons

Constant availability and functionality of the buttons is essential. This is why they are fully IP67-rated, providing extra protection against dust and water. All buttons are framed; this way they cannot be triggered unintentionally.

LED display function

The bright, fully illuminated two-colour LED buttons not only support the basic function of establishing calls but also double as display elements for status messages. They can indicate outgoing and incoming calls and messages, the status of outputs and alarms, and many other system events.

System: scalable, modular, easy to install

Individual combination options

Based on a modular building-block system, the device offers many customisation options. This way, it can be tailored to meet a wide range of individual customer and project specific requirements. Commend also offers the option of custom-made modules, including seamless integration into your communication solution.

Easy module replacement

In case individual modules are damaged, you can simply change the affected parts without the need to replace the entire station.

Easy to install

No separate installation kit is required to mount and install the basic housing. This means, no hidden costs or additional expenses for your budget.

Flexible cable inlet options

There is no need to compromise when installing the unit: there are cable inlet options on all four sides to suit your installation environment.

No risk of damage during installation

The basic housing is equipped with a "hinge system" that minimises the risk of inadvertent damage to the components when performing installation or service work. As a result, the unit can be installed and configured with effortless ease.

Electronic system: technically advanced and reliable

Hardware/software system based on cutting-edge technology

The combination of latest-generation hardware and flexible software ensures ultimate availability and a wide range of unique functions, such as:

- Audio monitoring for keeping an electronic ear on ambient noise levels, e.g. for acoustic surveillance of machines or processes.
- Continuous function self-monitoring of the station (loudspeaker, microphone or communication lines).
- Automatic volume adjustment based on ambient noise levels.
- Public Address functions, e.g. for playback of pre-recorded messages or issuing.
- Time-based or workflow-based scheduling of system actions.
- Various speech transmission modes to ensure perfect intelligibility depending on the application environment, e.g. for conference calls, party lines, direct calls or dial-up calls.

Integration of customer-specific requirements

New functions and special customer requirements can be implemented easily and conveniently via software updates.

Open to extensions

The system can easily be extended through add-on equipment such as handsets, signal lights or foot-operated buttons. All devices of Series EE 8000 are equipped with the required connectors by default.

Enhanced range of functions thanks to camera module

The optionally available camera module allows for previously impossible levels of video integration for industrial stations.

Intelligent control and automation

Additional features include multiple integrated I/Os for control, surveillance and integration of external devices (e.g. for signal lights or sensors).

Cabling made easy

The device's wire-saving 2-wire cabling technology offers great advantage with respect to cabling and system integration.

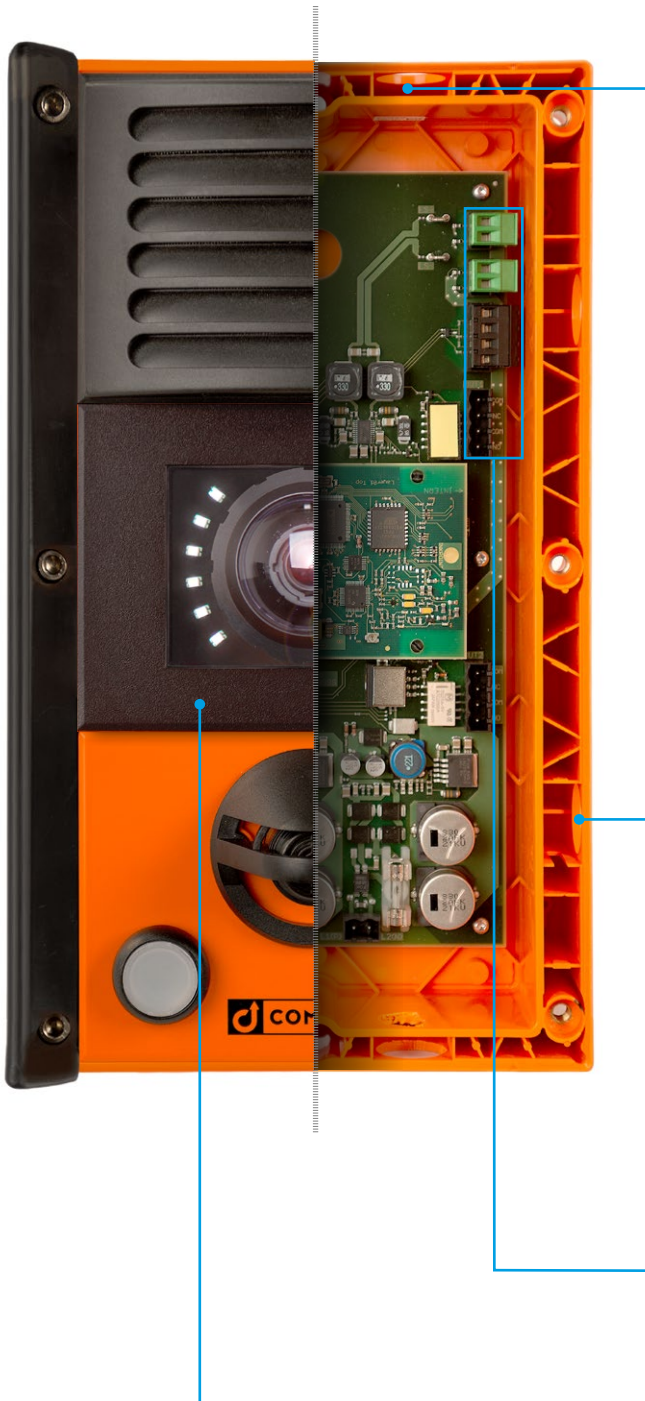

Loudspeaker: loud and clear – in any situation

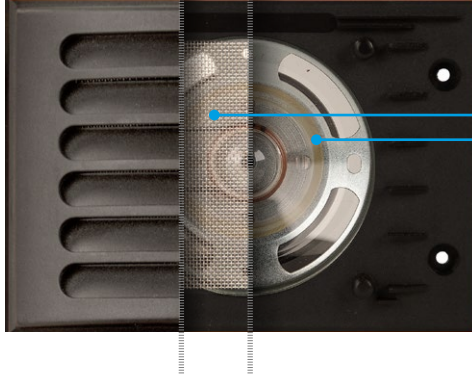

Powerful sound amplifier as a standard feature

Unlike comparable Intercom stations, Series EE 8000 devices are equipped with a highly efficient 25 watt class-D amplifier by default. This eliminates the need for an upgrade to add sound amplification capabilities.

Loudspeaker with extra efficiency inside

The built-in loudspeaker ensures the required sound volume and superior speech intelligibility – even in extremely noisy environments.

Sturdy protective grid

The loudspeaker is equipped with a metal grid to protect it against mechanical damage, foreign bodies or insects – this is particularly important in outdoor environments.

Resistant membrane

The devices are covered with a special water-proof, weather-resistant membrane to ensure their suitability for industrial environments.

Flexible connection options

If required, it is possible to connect external loudspeakers, e.g. for Public Address purposes and similar applications.

Microphone: secure and reliable

Adjustable speaking distance and optimal speech transmission

The microphone's sensitivity can be adjusted to local conditions, which ensures ultimate speech intelligibility. In this way, the microphone can easily be configured for long or short speaking distances as needed.

Resistant against wind and weather

A Gore-Tex based membrane protects the microphone against dust and helps to minimise wind noise. Thanks to a Teflon-based gasket, the device is also protected against the ingress of water.

Robust protective cover

The microphone is also equipped with a precision-crafted protective cover, which prevents mechanical damage and increases the protection against water.



Function-oriented design

The modular concept

The modular concept of this product allows for flexible, customer specific configuration of the Intercom stations. Each module serves a specific purpose hence there are various devices with different functions.

Product code

Each station has a unique code, which is defined by the modules used for that specific product. The complete order code composition consists of the following sub codes:



Example:

EE 8 1 5 8 M

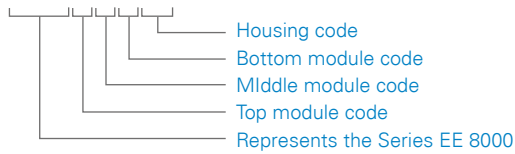

Basic and expansion housings



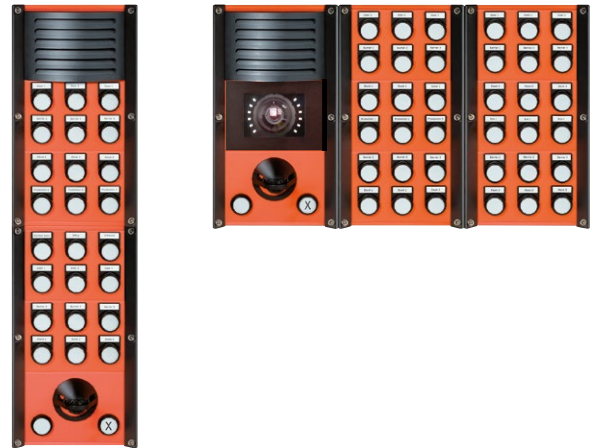













One basic housing can be combined with up to 2 expansion housings. This way, Intercom stations with up to 50 freely programmable buttons can be configured. The modules are connected to the PCB of the housing and can be combined as described in the positioning table on the next page. The cabling, also for multiple housings, is done with only 2 wires to the Intercom server and 2 wires to the power supply. The housings are combined using the mounting kit EE 8999-KIT.



Index of housings

Product code	Housing code	Features and specifications	Image (front, side)
EE 8999M	M	Basic housing with 3 module slots, includes electronics, cable glands, expansion openings on four sides and dummy plugs.	
EE 8999MSOS	MSOS	Basic housing with 3 module slots, includes electronics, cable glands, "SOS" imprint on both sides (hence the expansion openings are only at the top side and bottom of the unit).	
EE 8999S	S	Expansion housing with 3 module slots, includes electronics, cable glands, expansion openings on all four sides and dummy plugs. The mounting kit (EE 8999-KIT) for expansion housings is available separately.	
EDI 600	E	Empty housing without electronics.	without illustration

Index of modules

Product code	Module code	Features and specifications	Image	EE 8999M module slot	EE 8999S module slot
EM 600	0	Dummy module for covering empty module slots or for mounting of customer specific buttons.			
EM 6A0	A	Dummy module imprinted with "SOS" for covering empty module slots.			
EM 650	1	Loudspeaker module offering a high sound pressure level and an excellent intelligibility of speech. 15 W output power; sound pressure level 96 dB/1 W/1 m/1 kHz; impedance 8 Ω.			 (1)
EM 602	2	Keypad module with buttons 1 to 6 as part of a full keypad. Various functions can be assigned to the buttons.			
EM 603	3	Keypad module with buttons 7 to X as part of a full keypad. Various functions can be assigned to the buttons.			
EM 606	4	Keypad module with 6 buttons that can be custom-labelled. Various functions can be assigned to the buttons. Tags are included for labelling the buttons.			
EM 605	5	Keypad module with 6 LED buttons that can be custom-labelled. Various functions can be assigned to the buttons. Tags are included for labelling the buttons.		 (2)	 (2)
EM 660	6	Microphone module with a universal microphone and 2 buttons. Various functions can be assigned to the buttons. Optional button labels L and X are included in extent of supply.*			
EM 680	8	Microphone module with a universal microphone and 2 LED buttons. Various functions can be assigned to the buttons. Optional button labels L and X are included in extent of supply.*			
EM 681	D	Microphone module with a universal microphone, 1 LED button and 1 large red mushroom button imprinted with "SOS". The two buttons can be programmed for various functions.*			
EM 6B0	B	Microphone module with a universal microphone, white conversation lamp and large red mushroom button imprinted with "SOS". Various functions can be assigned to the buttons.*			
EM 6CA	C	Camera module with Axis colour video camera and LED lighting. The viewing angle can be mechanically adjusted by 18° horizontally/25° vertically. Video streams are possible in the formats H.264 (MPEG-4 Part 10/AVC), H.265 (MPEG-H Part 2/HEVC) and MJPEG with a maximum resolution of 1920 × 1080 pixels.		 (3)	 (1)

* The DSP technology enables the characteristics of both an omnidirectional and noise cancelling microphone. Microphone sensitivity is adjustable from -21 dB to +12 dB. Speaking distance ranges from 3 cm (1.18 in) to 5 m (16.4 ft) (depending on ambient noise and microphone sensitivity settings); ambient noise level up to a maximum of 120 dB(A).

- (1) This module can only be connected to the EE 8999M (requires longer connection cables).
- (2) Not possible in combination with microphone modules EM 660 and EM 6B0.
- (3) It is recommended to use this module in the middle slot of the housing.

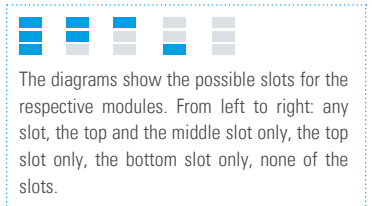

Standard versions of Series EE 8000



EE 8158M



EE 8148M



EE 8238M



EE 8108M



EE 81ADMSOS

Setup of the Intercom stations

The Intercom stations are made of extremely rugged polyester carbonate in a high-visibility bright orange colour (RAL 2004). The housing has additional impact protection strips on each side. Large buttons enable operation with work gloves. The buttons with two-colour LEDs (red, green – steady or blinking) can be used for status indication, e.g. for inputs, outputs, conversations or call requests. All buttons of the Intercom stations are fully programmable and can be assigned to predefined functions. Additional accessories like handsets, signal lights and such can be connected. Two relays on the base PCB can be assigned with various functions. The DSP technology enables additional functions, e.g. OpenDuplex®, loudspeaker/microphone surveillance or audio monitoring. Future functions can easily be added via a software update.

EE 8158M

Intercom station with 8 programmable LED buttons, built-in loudspeaker and universal microphone. The DSP technology facilitates a single microphone with both omnidirectional and noise cancelling characteristics. Button labels are included for marking the buttons' functions. The cable glands are included in extent of supply.

EE 8148M

Intercom station with 6 programmable buttons, built-in loudspeaker, universal microphone and two programmable LED buttons. The DSP technology facilitates a single microphone with both omnidirectional and noise cancelling characteristics. Button labels are included for marking the buttons' functions. The cable glands are included in extent of supply.

EE 8238M

Station with a full keypad, universal microphone, and 2 programmable LED buttons. The DSP technology facilitates a single microphone with both omnidirectional and noise cancelling characteristics. An external loudspeaker is required for this station. The cable glands are included in extent of supply.

EE 8108M

Station with 2 programmable LED buttons, built-in loudspeaker and universal microphone. The DSP technology facilitates a single microphone with both omnidirectional and noise cancelling characteristics. The cable glands are included in extent of supply.

EE 81ADMSOS

Station imprinted with "SOS" on the front and side panels, built-in loudspeaker, universal microphone, LED button and a large red mushroom button imprinted with "SOS". Both buttons can be assigned to various functions. The DSP technology facilitates a single microphone with both omnidirectional and noise cancelling characteristics. This station has no lateral expansion openings. The cable glands are included in extent of supply.

Series EE 8000

Technical specifications

Technical data

IP rating:	IP66 (acc. EN 60529)
Keypad:	industrial push-buttons with micro-switch
Housing:	PBT + PC (polyester-polycarbonate blend)
Microphone:	universal microphone microphone sensitivity configurable from -21 to +12 dB
Loudspeaker:	special membrane type for optimal sound quality 8 Ω
External loudspeaker:	8 or 16 Ω
Amplifier:	integrated class-D amplifier with 25 W impedance: 8 Ω
Maximum sound pressure level (25 W/0.3 m):	built-in loudspeaker: 120 dB horn loudspeaker HP10: 126 dB horn loudspeaker HP15: 126 dB
Maximum ambient noise level:	up to 120 dB
Handset input:	EM sensitivity: 14 mV _{eff} EM impedance: 3.3 kΩ, EM supply: 1.5 V EP level: 600 mV _{eff} at 0 dBm0, EP impedance: 200 Ω
Inputs:	2 digital inputs for floating contacts
Outputs:	2 floating relay outputs ¹⁾ max. 60 W (DC)/62.5 VA (AC) max. 2 A max. 60 VDC/30 VAC expected life: min. 5 × 10 ⁵ (2 A), 2 × 10 ⁵ (1 A)
Frequency range:	200 Hz to 7 kHz
Operating temperature range:	-20 °C to +70 °C (-4 °F to +158 °F) ²⁾
Storage temperature range:	-30 °C to +85 °C (-22 °F to +185 °F)
Relative humidity:	up to 95%
Connections:	pluggable screw terminals
Power supply:	24–30 VAC _{eff} (33–42 VAC _{peak})/40 VA ¹⁾ or 22–60 VDC/40 W
Cabling:	star feed, 2 wires, twisted pair + power supply
Signalling:	2B + D (2 × 64 kBit/s speech, 16 kBit/s data)
Dimensions (W × H × D):	with impact protection strips: 177 × 312 × 120 mm (6.97 × 12.28 × 4.72 in)
Weight incl. packaging:	EE 8158M: 3,200 g (7.1 lbs) EE 8148M: 3,340 g (7.4 lbs) EE 8238M: 2,960 g (6.5 lbs) EE 81ADMSOS: 3,100 g (6.8 lbs) EE 8999M: 2,300 g (5.1 lbs) EE 8999MSOS: 2,300 g (5.1 lbs) EE 8999S: 2,240 g (4.9 lbs)
Colour:	orange (RAL 2004)

¹⁾ All connected circuits must meet the following safety requirements:

- Safety extra-low voltage (SELV) and limited power supply (LPS) according to IEC/EN 60950-1 or
- ES1, PS2 circuits and Annex Q (power-limited power supply) according to IEC/EN/UL 62368-1. A SELV/ES1 circuit must be safely separated from a dangerous electrical circuit (e.g. 230 V or 110 V mains power), e.g. by double insulation. The SELV circuit must not exceed 60 VDC or 42.4 VAC_{peak} (30 VAC_{eff})!

²⁾ When using the camera module EM 6CA, observe its operating and storage temperature ranges (see page TE | 2)!



Line length

Cable type	max. line length
J-02YS(St)Y: Cat. 5 cable, foamed polyethylene; ø 0.6/0.8 mm; AWG: 22/20 Capacity: 45 nF/km (30.5 nF/1,000 ft)	3,000 m (9,843 ft)
F-YAY (installation cable PVC); ø 0.6/0.8 mm; AWG: 22/20 Capacity: 100 nF/km (30.5 nF/1,000 ft)	2,000 m (6,562 ft)

System requirements

Intercom Servers GE 800/GE 300

- GE 800 (min. PRO 800 1.0) with G8-GED or
- GE 300 (min. PRO 800 1.0) with G3-GED
- Configuration software min. CCT 800 1.0

Intercom Servers GE 700/GE 200

- GE 700 (min. Pro 05.7 build 15) with G7-GED-4 (min. 02.2) or
- GE 200 (min. Pro 05.7 build 15) with G2-GED-4
- Configuration software min. CCT 5.7 build 12

Extent of supply

- Industrial station
- Short reference
- 3 × M20 cable glands
- 10 × dummy plugs
- Button labels (when ordering the EE 8158M or EE 8148M)

Note – recommended accessory:

Power supply unit PA65W48V

EM 6CA

Technical specifications

General

Memory and storage:	1024 MB RAM, 512 MB Flash support for microSD/microSDHC/microSDXC card with UHS Speed Class U1 support for recording to network-attached storage (NAS) for SD card and NAS recommendations see axis.com
Power supply camera:	PoE
Power supply camera illumination:	48–60 VDC ¹⁾
Operating temperature range:	-20 °C to +60 °C (-13 °F to +140 °F) intermittent ²⁾ , +50 °C (+122 °F) permanent
Storage temperature range:	-25 °C to +60 °C (-13 °F to +140 °F)

¹⁾ All connected circuits must meet the following safety requirements:

1. Safety extra-low voltage (SELV) and limited power supply (LPS) according to IEC/EN 60950-1 or
2. ES1, PS2 circuits and Annex Q (power-limited power supply) according to IEC/EN/UL 62368-1. A SELV/ES1 circuit must be safely separated from a dangerous electrical circuit (e.g. 230 V or 110 V mains power), e.g. by double insulation. The SELV circuit must not exceed 60 VDC or 42.4 VAC_{peak} (30 VAC_{eff})!

²⁾ For a period of 4 hours

Camera

Image sensor:	1/2.9" progressive scan RGB CMOS
Lens:	2.8 mm, F1.2, fixed aperture
Minimum focus distance:	0.3 m (1 ft)
Total camera angle of view (incl. mechanical adjustment range):	141° horizontally, 102° vertically
Camera angle adjustment (mechanical):	± 18° horizontally, ± 25° vertically
Minimum illumination:	color: 0.02 lux at 30 IRE F1.2 color: 0.07 lux at 50 IRE F1.2
Shutter time:	with WDR ³⁾ : 1/19,000 s to 1/5 s without WDR ³⁾ : 1/17,000 s to 1/5 s

³⁾ Wide Dynamic Range

Video

Video compression:	H.264 (MPEG-4 Part 10/AVC) Baseline, Main and High Profiles, H.265 (MPEG-H Part 2/HEVC) Main Profile Motion JPEG
Resolution:	16:9: 1920 x 1080 to 640 x 360 pixels 16:10: 1280 x 800 to 640 x 400 pixels 4:3: 1280 x 960 to 320 x 240 pixels
Frame rate:	H.264 and H.265: 25/30 fps (50/60 Hz) in all resolutions Motion JPEG: 15 fps (50/60 Hz) in all resolutions
Video streaming:	up to 4 unique and configurable video streams multiple, individually configurable streams in H.264, H.265 and Motion JPEG Axis Zipstream technology in H.264 and H.265 controllable frame rate and bandwidth VBR/ABR/MBR H.264 and H.265 video streaming indicator
Image settings:	compression, brightness, sharpness, contrast, white balance, forensic WDR, exposure control, exposure zones, fine tuning of behavior at low light, rotation: 0°, 90°, 180°, 270° including corridor Format, dynamic overlay, 32 individual polygonal privacy mask, mirroring of images, scene profiles: forensic, vivid, traffic overview



Features and highlights

- Built-in Axis camera with LED illuminator
- Multiple H.264, H.265 and MJPEG streams
- Compatible with third-party video components, e.g. NVRs
- Excellent video quality, including Full HD 1080p
- Wide angle of view
- Video functions, e.g. motion detection or recording
- Vandal resistant and detection of tampering attempts such as blocking or spray-painting
- IP rating IP66 and mechanical impact resistance IK09

Camera component information

The camera component included in this product is made by the independent manufacturer AXIS Communications. The responsibility for safe operation lies solely with the operator.

EM 6CA

Technical specifications (continued)

Network

Security:	IEEE 802.1x (EAP-TLS, PEAP-MSCHAPv2), IEEE 802.1AE (MACsec PSK/EAP-TLS), IEEE 802.1AR, HTTPS/HSTS, TLS v1.2/v1.3, Network Time Security (NTS), X.509 Certificate PKI, host-based firewall
Supported protocols:	IPv4, IPv6 USGv6, HTTP, HTTPS, HTTP/2, TLS, QoS Layer 3 DiffServ, FTP, SFTP, CIFS/SMB, SMTP, mDNS (Bonjour), UPnP®, SNMP v1/v2c/v3 (MIB-II), DNS/DNSv6, DDNS, NTP, RTSP, RTP, SRTP, TCP, UDP, IGMPv1/v2/v3, RTCP, ICMP, DHCPv4/v6, ARP, SOCKS, SSH, LLDP, CDP, MQTT v3.1.1, Syslog, Link-Local address (ZeroConf)

System integration

Programming Interface:	open API for software integration, including VAPIX® and AXIS Camera Application Platform (ACAP); specifications at axis.com/developer-community . ACAP includes Native SDK. One-click cloud connection ONVIF® Profile G, ONVIF® Profile M, ONVIF® Profile S and ONVIF® Profile T, specification at onvif.org
Analytics:	included AXIS Video Motion Detection, active tampering alarm ³⁾ supported AXIS Fence Guard, AXIS Loitering Guard, AXIS Motion Guard support for AXIS Camera Application Platform enabling installation of third-party applications, see axis.com/acap
Event conditions:	device status: above operating temperature, above or below operating temperature, below operating temperature, IP address removed, network lost, new IP address, storage failure, system ready, within operating temperature edge storage: recording ongoing, storage disruption I/O: manual trigger, virtual input MQTT subscribe scheduled and recurring: scheduled event video: average bitrate degradation, live stream open, tampering
Event actions:	guard tours upload images or video clips: FTP, HTTP, HTTPS, SFTP, email and network share notification: HTTP, HTTPS, TCP and email overlay text preset positions record video: SD card and network share SNMP trap messages WDR mode MQTT publish

³⁾ For detection of tampering attempts in static and non-crowded scenes.

Line length in LAN

The maximum line length of Cat. 5 cabling in a LAN is 100 m (328 ft) – e.g. from switch to Intercom station.

Security instructions

- The responsibility for secure operation lies solely with the operator. Appropriate precautions, in particular the choice of a secure root password, are their responsibility. For instructions on password safety, see the product manual “**Cyber security hardening and application guideline**”
- Regularly check the Commend Security Advisories in cLibrary under <https://clibrary.commend.com/en/cyber-security/security-advisories> as well as the AXIS Communications support website under <https://www.axis.com/en-gb/support>.

Video notes

For video to be displayed on subscribers of types WS-TM 50x, WS 810x and CD 810x, set the field **Authentication policy** to the value **Basic**. This setting is available with Axis Long Term Support firmware LTS2024 track (11.11). It may no longer be supported in newer firmware versions.

A maximum resolution of 800 × 600 pixels is supported when operating with EE 980 subscribers.

Series EE 8000

Installation instructions

Safety instructions

- This device shall be installed or replaced by trained and qualified personnel only.
- Do not expose the device to extreme temperatures (below $-20\text{ }^{\circ}\text{C}/-4\text{ }^{\circ}\text{F}$ or above $+70\text{ }^{\circ}\text{C}/+158\text{ }^{\circ}\text{F}$).
- Only use recommended tools when installing the device.
- Observe the country-specific standards for installation, mounting and configuration.
- All connected circuits shall fulfil the following requirements:
 - Safety Extra Low Voltage (SELV) and Limited Power Source (LPS) according to IEC/EN 60950-1 or
 - ES1, PS2 circuits and Annex Q (Limited Power Source) according to IEC/EN/UL 62368-1
- Only accessories that comply with the device's technical specifications shall be used.
- Do not make any unauthorised modifications to the device.
- Digital inputs:

When wiring and selecting the connected switching elements, it must be ensured that they are designed with insulation according to EN 62368-1:2014 chapter 3.3.11.1 (BASIC PROTECTIVE DEVICE) with a minimum insulation voltage of 1500 V.
- Axis electronic module EM 6CA:

This is a Class A product (standard EN 55032). In a domestic environment, this product may cause radio interference, in which case the user may be required to take adequate measures.

Installation instructions

- The following mounting material is recommended for installing the Intercom station:
 - Dowel $\text{Ø}8 \times 50\text{ mm}$
 - Tapping screw $\text{M}4.8 \times 80\text{ mm}$, with pan head DIN 7981
 - Washer $\text{M}5\text{ DIN}125\text{A}$
- When opening the Intercom stations, ESD precautions must be observed.
- Do not install the Intercom station on unstable walls or on surfaces, which cannot support the device's weight.
- Ensure distortion-free installation (e.g. on uneven walls).

Recommended mounting height

Regardless of whether a single industrial Intercom station or a combination of stations is used in a vertical or horizontal arrangement: The microphone should be positioned at a height of approx. 1.40 m (4.6 ft) above the floor. Adapt the mounting height to individual needs.

Horizontal combination of stations and/or single station

The upper edge of the station(s) approx. 1.65 m (5.4 ft) from the finished floor:
The microphone is therefore positioned at a height of approx. 1.40 m (4.6 ft) above the floor.

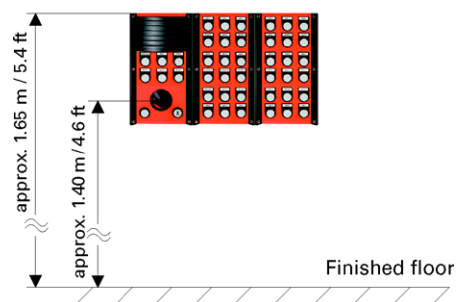

Vertical combination of stations

Regardless of whether a combination of 2 or 3 stations is used:
The microphone should be positioned at a height of approx. 1.40 m (4.6 ft) above the floor.

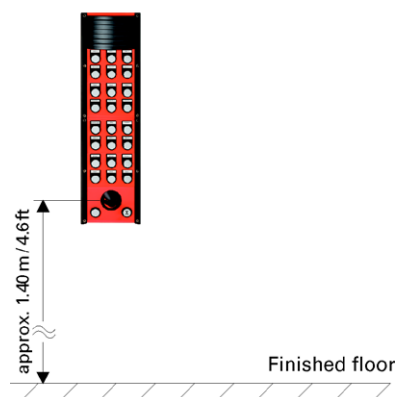

Connection diagram EE 8999M

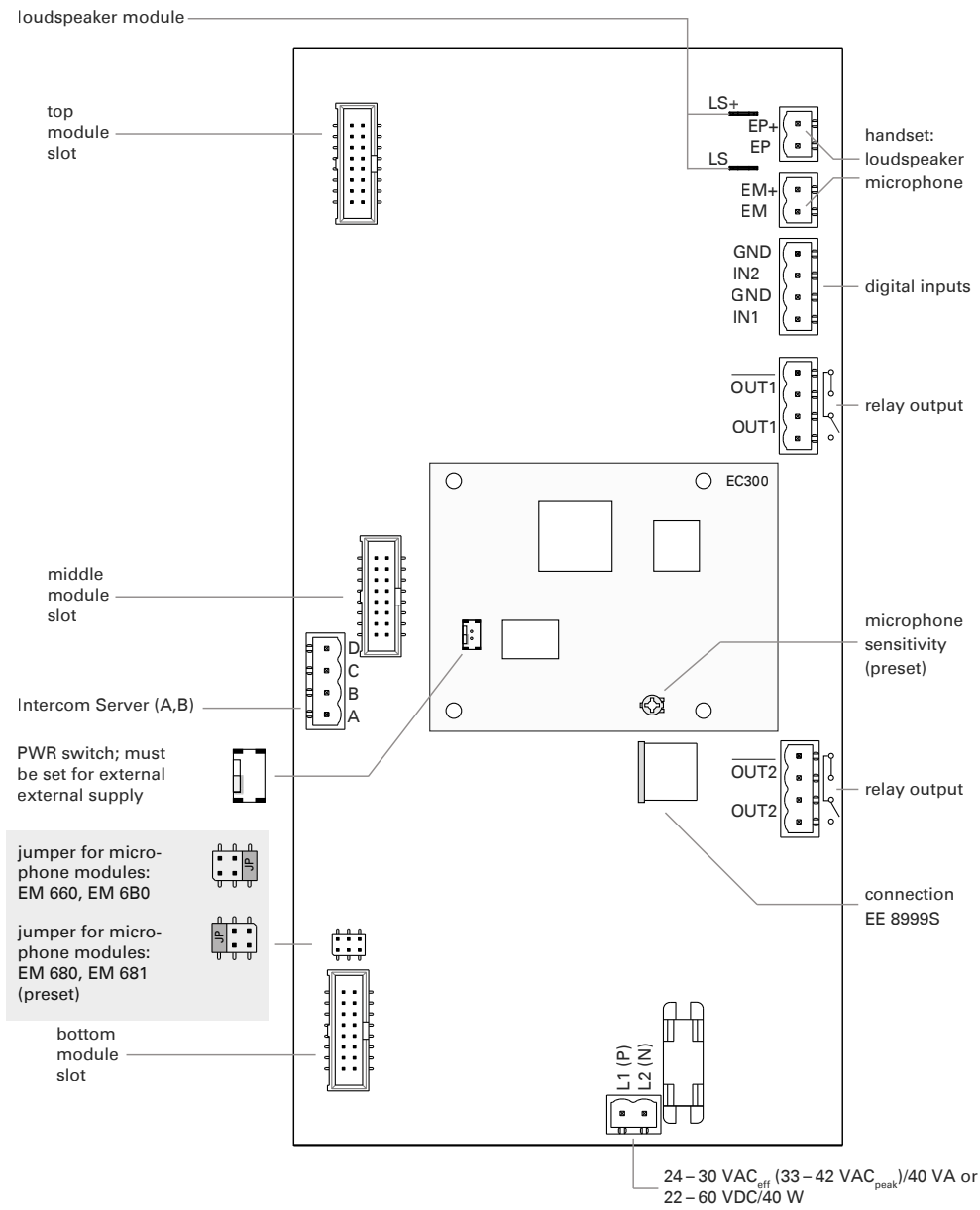

Connection diagram Axis electronic module EM 6CA

Connection for the power supply of the camera:

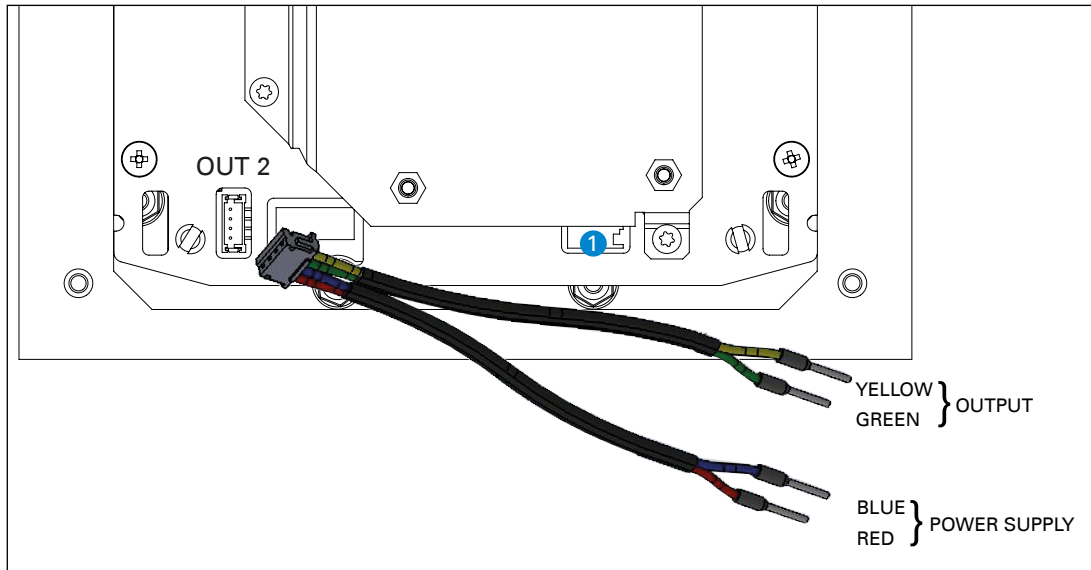

- Plug the connection cable into the OUT 2 connector of the Axis camera LED PCB.
- Connect the connection cable (red and blue wire) to the power supply of the EE 8000 PCB or to the external power supply unit.
 - RED wire to L1 (P)/power supply 48 to 60 VDC required!
 - BLUE wire to L2 (N)
- Connect the connection cable (green and yellow wire) to OUT 1 or OUT 2 of the EE 8000 PCB.
 - GREEN wire to NO
 - YELLOW wire to COM
- Configuration CCT 800:
 - The respective output (OUT 1 or OUT 2 on the EE 8000 board) has to be configured with the program CCT 800 to switch the camera illuminator on/off. It is also possible to use the output as attendant contact, e.g. to switch on the camera illuminator at call setup.
- To dim the camera illuminator, use the potentiometer ① on the Axis camera LED PCB.

EM 6CA – memory card slot

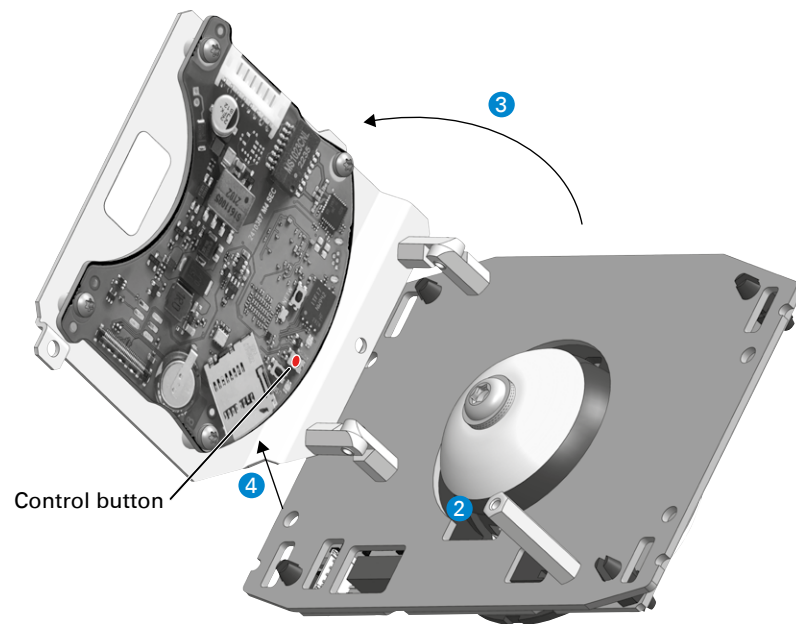

Inserting a memory card

Follow the steps below to insert a memory card into the module:

- Loosen the screw ② (Torx T8).
- Open up the Axis camera module ③. Avoid damage to the connection cable.
- Insert the memory card into the card reader ④.
- Close the Axis camera module ③. Avoid damage to the connection cable.
- Tighten the screw ②.

EM 6CA – camera angle/web interface login

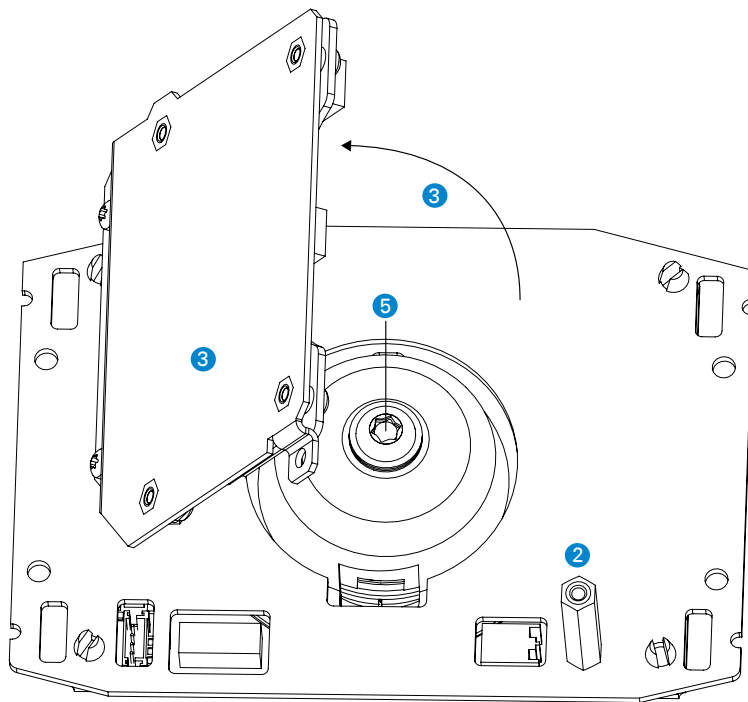

Adjusting the camera

Follow the steps below to adjust the angle of the camera:

- Loosen the screw ② (Torx T8).
- Open up the Axis camera module ③. Avoid damage to the connection cable.
- Loosen the locking screw ⑤ (Torx T25) on the rear of the camera.
- Adjust the camera angle as desired (max. 18° horizontally/25° vertically).
- Tighten the locking screw ⑤.
- Close the Axis camera module ③. Avoid damage to the connection cable.
- Tighten the screw ②.

First connection

The IP address is assigned directly via a DHCP server. If the network does not have a DHCP server, the default address "192.168.0.90/24" is used.

The web interface can be accessed via a web browser using the URL "http://<IP address>". Additionally, the URL "http://<username>:<password>@<IP address>/axis-cgi/mjpg/video.cgi" can be entered in a web browser to directly access the MJPEG stream.

Note: For further information on installation and settings, see Axis manual "M3905-R".

Quality tested. Reliable. Smart.

COMMEND products are developed and manufactured by Commend International in Salzburg, Austria.

The development and manufacturing processes are certified in accordance with **EN ISO 9001:2015**.



The technical data contained herein has been provided solely for informational purposes and is not legally binding. Subject to change, technical or otherwise. lolP®, OpenDuplex® and Commend® are trademarks registered by Commend International GmbH. All other brands or product names are trademarks or registered trademarks of the respective owner and have not been specifically earmarked.

A strong worldwide network

COMMEND is represented all over the world by local Commend Partners and helps to improve security and communication with tailored Intercom solutions.

www.commend.com