

im6

The world's first real multi-sensory Intercom module



	Ready for Symphony Cloud
Modular solution	Fully IP-based
Supports display & camera	Future-proof system

Powerful built-in solution

The im6 is a powerful basic-core Intercom module that brings the power of the Concerto Series' Intercom multi-connectivity for buildings, industrial and similar environments to the world of OEM system integration.

The im6 is the first solution worldwide that can bring together a variety of communication, display and control sources on a compact single-source device. With lots of options for audio, video and display connectivity, it acts as a one-stop communication hub that caters to all "communicative senses". This makes it the most flexible Intercom module, giving operators an easy one-stop option to custom-build combined communication and information display solutions to suit their individual needs.

Ready for Symphony Cloud Services

The Intercom stations can be connected to Symphony and use its services. Symphony is the world's first cloud-based Intercom platform with "Privacy and Security by Design". Visit the Symphony website to find out about the services currently available and if they are already offered in your country.

symphony.commend.com

Features and highlights

- Display connection via HDMI and touch link via USB
- Supports the Commend camera module cm1
- High volume and best speech intelligibility thanks to the integrated class-D amplifier
- Special audio functions provide high speech quality in any situation
- Crystal-clear sound with up to 20 kHz audio quality
- OpenDuplex® for natural, hands-free communication
- Compact and rugged housing with RJ45 jack for easy installation
- Integrated inputs and outputs – expandable via USB connections
- Pluggable spring-type terminals enable simple and fast connection of cables
- Easy to expand with add-on equipment via USB interface
- 3 inputs for floating contacts and 2 relay outputs

Accessories

Camera module cm1

With the cm1, an im6 can be equipped with a high-quality, high-performance camera. The timeless and inconspicuous design makes it suitable for modern buildings. Via the HS-Link connection, the camera module can be installed with a distance of up to 3 m to the im6.



USB I/O module EB1E1A

With the USB I/O module EB1E1A, a base module can be expanded with an additional input and a relay output (normally open contact). The EB1E1A can be connected to a free USB port. By doing this, an input as well as a floating, galvanically-isolated output contact is available immediately – e.g. for use with a door opener.



USB I/O module EB8E8A

A device can be quickly expanded with inputs and outputs using the USB I/O module. The total of 8 inputs and 8 outputs of the EB8E8A enable an easily scalable solution. The EB8E8A complies with Commend's strict cyber security guidelines, e.g. for switching outputs. The module is connected using USB.



Power injector PA 25W POE-DC

In applications where PoE sourcing equipment is not available, the optional power injector PA 25W POE-DC offers a compact, convenient solution. It supports a wide DC input range (24–48 V) and is IEEE 802.3af/at compliant. The power injector connects easily and conveniently to an Intercom station through an Ethernet cable.



Microphone MIC 480

The MIC 480 is a high-quality microphone specially designed for harsh outdoor environments. It can be installed for use with Intercom stations in parking columns, ticket machines or elevator panels or used as a customer-side microphone for counter intercoms.



NOTE

The device supports connecting 1 USB device of the same type at any time. Example: 1 EB3E2A-AUD and 1 EB1E1A.

Expansion module EB3E2A-AUD

The EB3E2A-AUD expansion module provides an easy way to expand the I/O and audio capabilities of an Intercom station. The expansion module is suitable for any applications where additional inputs and outputs are required. It has three inputs, two output relays and ports for direct connection of an external loudspeaker, external microphones and handset. Line-in and line-out connectors provide additional flexibility. The module can be connected to the Intercom station through a USB cable and is immediately available in the system.



Safety switch box IP Secure Connector

The IP Secure Connector provides high performance and high, absolute security, even if the connected Intercom station is located outdoors: If an unauthorised attempt is made to remove the Intercom station, e.g. to access the connected Ethernet cable, the IP Secure Connector interrupts the connection to the Intercom station and LAN. This ensures that it is neither possible to access the network nor to open a door or gate. Furthermore, the IP Secure Connector provides power supply in form of PoE+ and has two inputs and three outputs.



Induction loop kit AFIL-USB

With the AFIL-USB, an Intercom station can easily and quickly be equipped with an induction loop amplifier module. To do so, only a free USB jack is required at the station.



Loudspeaker LS8, LS15 or AL 10-16

With the LS8, LS15 or AL 10-16 (see image), an Intercom station can be equipped with an external loudspeaker.



Top-Hat Rail Clamp ET 901-HSH35

With the ET 901-HSH35, the im6 can be installed on a top-hat rail. It is possible to mount the Intercom module upright, vertically flat or horizontally flat.



System overview

Operation with Symphony Mesh

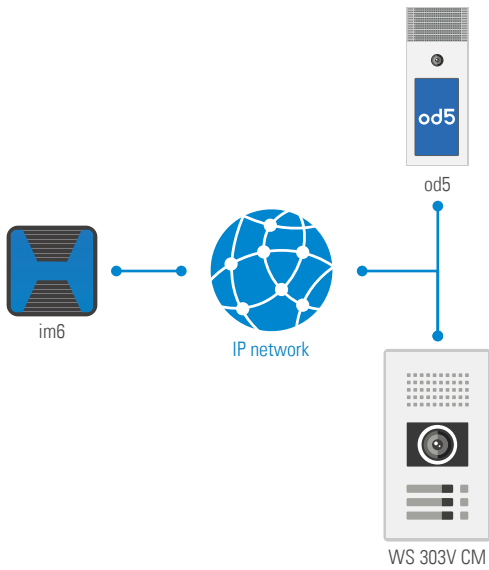

Operation with Symphony On-Prem

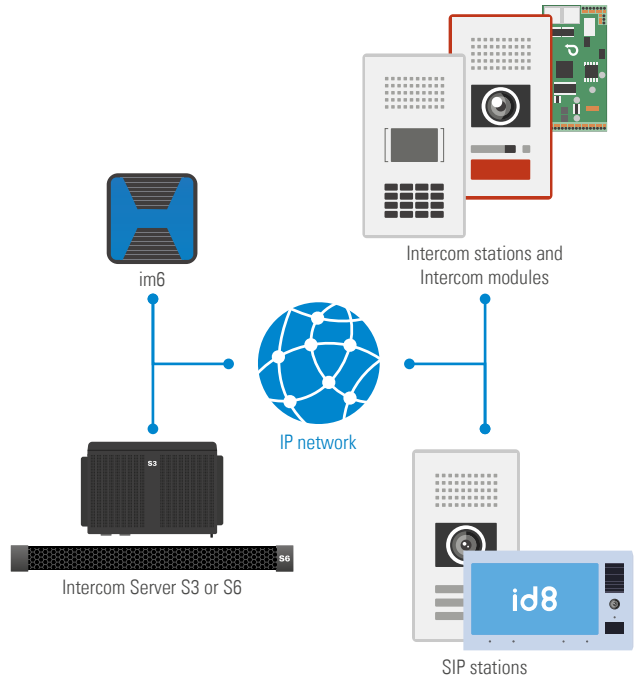

Application example

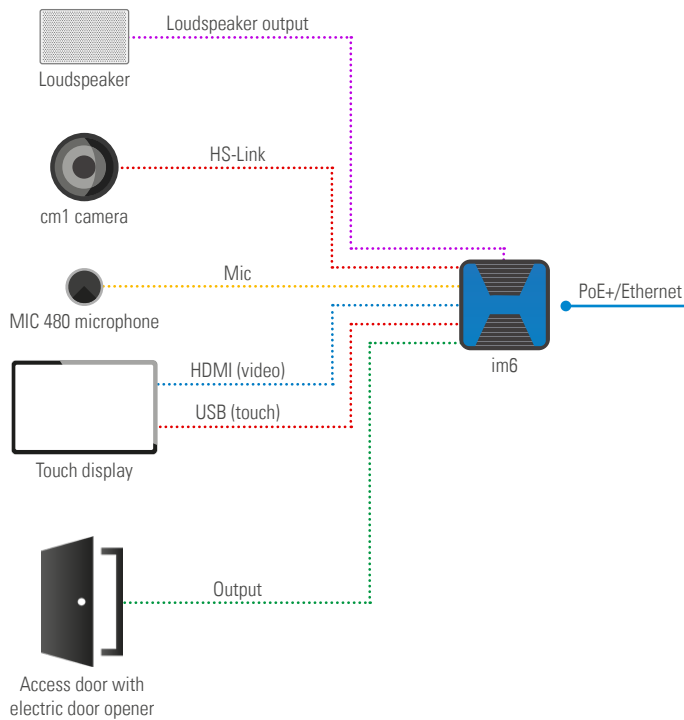

No matter what the idea is – simply build it!

The modular concept around the im6 and cm1 allows unprecedented freedom and creativity in building solution-specific communication applications. It is possible to create your own Intercom stations and information terminals using different elements (touch display, camera, etc.), to integrate them into other systems such as charging stations or to supplement lamps in public spaces with information and emergency call communication.



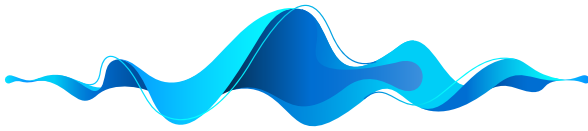

CERTIFIED
ACC. TO
ISO 27001
IEC 62443-4-1

Passion meets audio

Ultimate speech intelligibility

Because every word matters, high speech intelligibility is crucial in security and communication solutions. In everyday life, it enables natural and brilliant communication; in operational processes, it ensures improved efficiency and in an emergency often buys life-saving time.

AI CLEANS VOICE FROM NOISE

Echo cancellation

Our advanced echo cancellation technology leverages the power of Commend's proprietary **deep neural networks** to deliver unparalleled clarity. Experience smooth and natural conversations without any noticeable echoes or delays, ensuring effective communication every time.

Background noise suppression

To ensure that the other party clearly understands what is being said despite high levels of ambient noise, dynamic background noise suppression together with **beamforming** reduces interfering signal components effectively.

Dynamic volume adjustment

IVC (Intelligent Volume Control) automatically adjusts the loudspeaker volume of the Intercom station depending on the environment noise level – because both, too low and too high a volume, significantly reduces speech intelligibility and the user experience.

Hands-free communication through OpenDuplex®

This technology from Commend, combined with highly sensitive microphones as well as a high volume, allows natural and hands-free communication within a unique radius of several metres.

High volume

When there is ambient noise, the Intercom station has sufficient reserves to put out the audio signal of the other party at a higher volume than any distracting background sounds.

Audio functions adding value

- **Loudspeaker-microphone surveillance** – constant availability of Intercom stations while greatly reducing the manual testing effort.
- **Simplex mode** – for applications requiring controlled communication, e.g. security or industrial solutions based on the push-to-talk/release-to-listen principle.
- **Audio monitoring** – fully automated (emergency) call triggering at defined sound pressure levels for more security.
- **Live sound pressure level** – continuous measurement of ambient noise with optional transfer to a management system through SNMP or HTTP-S (e.g. to visualise noise volumes).
- **Equalizer** – for fine-tuning to ambient acoustic conditions.
- **Public address functions** – as an essential element of a holistic solution approach, announcements can be made or played back at every Intercom station as well as responded to directly.

For more information, visit:
audio.commend.com

Cyber security at Commend

Uncompromising protection against threats

IT infrastructures are facing a growing variety of cyber threats. This means that the defensive capabilities of each product in the system environment are key.

Security is above all a question of trust. At Commend, cyber security as a core competence has always been given a very high priority. From the initial product idea through implementation and operational support, privacy and security by design (PSBD) is the uncompromising target and promise to our customers against which product features and functions must be measured.

Cyber security as top priority

- Commend as well as the hardware and software development process is rigorously certified according to the standard **IEC/ISO 27001** and subject to a company-wide information security management system (ISMS)
- Commend is a member of the **Center for Internet Security (CIS)**
- Commend's Cyber Security Board ensures the handling and transparent communication of security vulnerabilities as well as the strategic hardening of Commend systems
- Commend is certified in accordance with the **IEC 62443-4-1** standard. The Commend development team implements secure communication and automation solutions in agreement with „Security by Design“ guidelines.
- Commend continuously publishes software updates with security patches and improvements

Physical security

- Robust devices and vandal-resistant product versions
- Tamper detection through electromechanical contacts
- USB and port-debugging protection

Network security

- **Standard IEEE 802.1x** for authentication (network access)
- **Standard IEEE 802.1q** for VLANs (network segmentation)
- Commend IP Secure Connector for automatic interruption of the network connection in the event of a tampering attempt

Data security

- **Encrypted and authenticated communication**
- **SIP over TLS v1.2** with secure cipher suites (> 128 bit)
- **SRTP** for tap-proof encryption of voice data
- **X.509 client certificates** for authentication and encryption
- TLS transport encryption for the protocols **HTTPS**, **SIPS** and **MQTT** to protect the web interface, APIs and video

Application security

- Mandatory change of the default password during the first login
- Minimum password length: 12 characters
- Detection of brute-force attacks at login
- Documentation and securing of network ports

Information about the cyber security of other Commend products can be found in the respective data sheets and product manuals.

For more information, visit:
trust.commend.com

im6

Technical specifications



Technical data

IP rating:	IP20 (acc. to EN 60529)
Mechanical impact resistance:	IK05 (acc. to EN 62262)
External LED:	possibility for connection of an RGB LED
Inputs:	3 inputs for floating contacts ¹⁾ (switches, push-buttons, relay outputs, etc.)
Outputs:	2 relay outputs max. switching voltage: 60 VDC, 30 VAC ²⁾ max. switching current (per output): 2 A ³⁾ max. switching power (per output): 60 W (DC), 37.5 VA (AC) expected electrical life: min. 10 ⁵ (30 VDC/2 A), min. 2 x 10 ⁵ (30 VDC/1 A)
Microphone input:	sensitivity (electret condenser microphone): -43 dBV/Pa feeding voltage: 2.5 V at 10 kΩ
Line-in:	sensitivity: 0 dBu (775 mV) input impedance: 7 kΩ can be switched as second microphone input (see above)
Loudspeaker output:	power: 5 W (RMS) at 8 Ω, 10 W (RMS) at 4 Ω, max. 15 W (peak) total harmonic distortion (THD+N): < 0.2% loudspeaker impedance: ≥ 4 Ω
Amplifier:	integrated class-D amplifier
Audio bandwidth:	up to 20 kHz
Audio codecs:	Opus, G.722, G.711 a-law and G.711 u-law
Display resolution:	max. 1280 x 800 px
Camera resolution:	max. 1280 x 960 px
Video streaming:	simultaneously up to 6 HTTP(S)/RTSP H.264 video streams with individual resolution or frame rate and simultaneously up to 6 HTTP(S) MJPEG video streams with individual resolution or frame rate
Video features ⁴⁾:	codecs: H.264 (SIP video and ONVIF), MJPEG (HTTP video and ONVIF) and RTSP ONVIF specification: ONVIF Profile S
IT security:	SIP via TLS, SRTP, IEEE 802.1X, MJPEG via HTTPS, HTTPS for accessing the web interface and interfaces
Protocols:	IPv4, IPv6, TLS, TCP, UDP, HTTP (RFC 2617, RFC 3310), HTTPS (RFC 2818), RTP (RFC 3550), RTSP (RFC 2326), SIP over TLS, RTCP, DHCP, DHCPv6, DNSv4, DNSv6, mDNS, 802.1x EAP-TLS (RFC 5216), 802.1x EAP-MD5 (RFC 2284), SDP (RFC 2327, RFC 4566), SSDP, SIP (RFC 3261), SMTP, SNMPv2c, SNMPv3, SNTpv4 (RFC 5905, Section 14), STUN (classicstun), DTMF Decoding (RFC 2976, RFC 2833, SIP Info), ICMPv6 (Router discovery), MQTT (ISO/IEC 20922)
Operating temperature range:	-40 °C to +70 °C (-40 °F to +158 °F) ⁵⁾
Storage temperature range:	-40 °C to +70 °C (-40 °F to +158 °F)
Relative humidity:	up to 95%, not condensing
Connection ⁶⁾:	I/O connector with spring-type terminal (20-pin, conductor cross-section: 0.14–0.5 mm ² , stripping length: 7 mm) 2 x USB 2.0 (Type A) HS-Link or USB 2.0 ⁷⁾ Micro HDMI (Type D, max. dimensions: 11.5 x 8 mm) RJ45 jack for Ethernet and PoE+ (10/100 Mbit/s)

Power supply ⁸⁾:	PoE+: IEEE 802.3at Type 2 Class 4
Power consumption:	idle: approx. 3.5 W (standalone) max.: 25 W ⁹⁾
Cabling:	min. Cat. 5, shielded
Approvals and compliances:	EN 61000-6-2, EN 61000-6-3, EN 55032 Class B, EN 55035, FCC Part 15 Class B, ICES-003 Class B EN 60529 IP20, EN 62262 IK05 EN 62368-1, IEC 62368-1 (CB-Scheme), UL 62368-1 (Listed E351589)
Dimensions (H x W x D):	28 x 86 x 95 mm (1.10 x 3.39 x 3.74 in)
Weight incl. packaging:	approx. 370 g (0.82 lbs)
Optional accessories:	cm1 (camera module) AFIL-USB (induction loop kit) EB1E1A (USB I/O module) EB8E8A (USB I/O module) EB3E2A-AUD (expansion module) IP Secure Connector (safety switch box) PA 25W POE-DC (power injector) ET 901-HSH35 (top-hat rail clamp) MIC 480 (microphone) LS8, LS15 or AL 10-16 (loudspeaker)

¹⁾ For the switching positing "ON", the switch resistance has to be less than 1 kΩ.

²⁾ The relay output may only be connected to an ES1 or a SELV circuit! An ES1 circuit as per IEC/EN/UL 62368-1 or a SELV circuit as per IEC/EN 60950-1 must be separated safely from a dangerous electrical circuit (e.g. 230 V or 110 V mains power), e.g. by means of double insulation. The ES1 or SELV circuit must not exceed 60 VDC or 42.4 VAC_{peak} (30 VAC_{eff})¹⁾.

³⁾ For the north American market (UL 62368-1 compliance), the max. supported current is limited to 1 A (AC)/0.6 A (DC).

⁴⁾ When using a Comend camera module cm1.

⁵⁾ From an operating temperature of 55 °C (131 °F), additional cooling must be provided (see mounting instructions).

⁶⁾ The USB connectors are PS1-declared and PS1-tested (acc. to EN/UL/IEC 62368-1).

⁷⁾ The HS-Link connection is intended only for the Comend camera module and Comend USB 2.0 modules. Do not connect any other devices to it.

⁸⁾ Use a PoE+ network switch or a PoE+ injector only. PoE+ acc. to IEEE 802.3at; output voltage 42.5–57 VDC; min. 25.5 W (via Ethernet port); LPS/PS2 or Class 2 output (IEC/EN/UL 62368-1).

⁹⁾ With touch display, cm1, microphone, loudspeaker (4 Ω), volume level "12" (1 kHz sine signal), 2 W load on each USB 2.0 connection and during a bi-directional video call.

Extent of supply

- Intercom module
- I/O plug
- Self-adhesive thermal pad
- Open source compliance information
- Device identification document
- Short reference

System requirements

- Serverless operation or
- VirtuoSIS (min. PRO 800 5.0, min. base licence PRO 3) or
- GE 800 with GB-VOIPSERV or
- Compatible SIP server

im6

Installation instructions

Mounting instructions

- Do not expose the device to extreme temperatures.
- Avoid direct sunlight.
- Observe the country-specific standards for installation, mounting and configuration.
- When mounting the device on a wall, its electrical connections should face downwards.
- Install or store this device out of the reach of children and do not allow persons unfamiliar with the device and these instructions to handle and operate the device.
- Use two screws with a suitable diameter (see “Dimensions”). Fastening, screw type and screw length depend on the mounting ground.
- For optimal heat dissipation at an operating temperature of more than 55 °C (131 °F), it is recommended to connect a cooling surface to the im6 using the supplied thermal pad. For this, choose exclusively a flat metallic cooling surface with a size of min. 440 cm² (173 in²).
- The final adhesion of the thermal pad is given after 24 hours. Therefore, it is recommended to fix the im6 with screws in addition to the thermal pad.
- The supplied thermal pad is only intended for one-time application and cannot be realigned after positioning.
- For mounting on a cooling surface, first remove the protective film from one side of the thermal pad and carefully stick it to the metal cooling plate of the im6. Make sure that the thermal pad is correctly aligned and free of bubbles. Then remove the remaining protective film from the thermal pad and press the im6 firmly onto the cooling surface in the desired position.
- Only use suitable lever tools to remove the cooling surface from the im6.
- For cabinet mounting, the top-hat rail clamp ET901-HSH35 can be used (available separately). The device can be mounted on the right side and on the back. Only use the screws in the extent of supply of ET901-HSH35 for this purpose.
- For flush mounting, the flush mount kits WSFB 50x or WSSH 50x can be used (available separately).
- Use shielded Ethernet cables and a grounded PoE+ power supply only.
- Before using the device, ensure all cables are connected correctly and not damaged.
- To avoid mechanical stress on the sockets, it is recommended to provide strain relief for the HS-Link cable and the HDMI cable below the device.

Line lengths

- The maximum line length of Cat. 5 cabling in a LAN is 100 m (328 ft) – e.g. from switch to device.
- The maximum line length of an input (IN1 to IN3), an output (OUT1 and OUT2) and a loudspeaker connection is 30 m (98 ft).
- The maximum line length of a USB connection is 5 m (16 ft).
- The maximum line length of the connections HDMI, Mic, Line-In and RGB-LED is 3 m (9 ft).
- The maximum line length of an HS-Link cable is 3 m (9 ft).

Safety instructions

- This device shall be installed or replaced by trained and qualified personnel only.
- Only use Commend accessories that comply with the device’s technical specifications.
- All connected circuits shall fulfil the following requirements:
 - Safety Extra Low Voltage (SELV) and Limited Power Source (LPS) according to IEC/EN 60950-1 or
 - ES1, PS2 circuits and Annex Q (Limited Power Source) according to IEC/EN/UL 62368-1
- Do not make any modifications to the device.
- This equipment has been tested and found to comply with the limits for a Class B digital device, pursuant to part 15 of the FCC Rules. These limits are designed to provide reasonable protection against harmful interference in a residential installation. This equipment generates, uses and can radiate radio frequency energy and, if not installed and used in accordance with the instructions, may cause harmful interference to radio communications. However, there is no guarantee that interference will not occur in a particular installation. If this equipment does cause harmful interference to radio or television reception, which can be determined by turning the equipment off and on, the user is encouraged to try to correct the interference by one or more of the following measures:
 - Reorient or relocate the receiving antenna.
 - Increase the separation between the equipment and receiver.
 - Connect the equipment into an outlet on a circuit different from that to which the receiver is connected.
 - Consult the dealer or an experienced radio/TV technician for help.

Access

The device can be accessed through IPv4 (DHCP), IPv6 (link-local) and zero-conf. For information on accessing the web interface, see the product manual.

Dimensions

Measuring units in mm (in), not to scale!

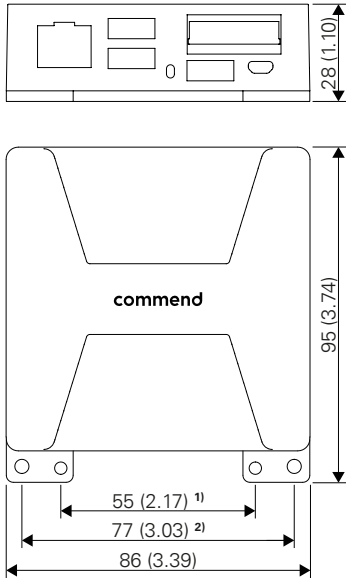

- ¹⁾ Mounting holes for flush mount box, \varnothing 3 mm
- ²⁾ Bore holes for wall mounting, \varnothing 4 mm

Connection

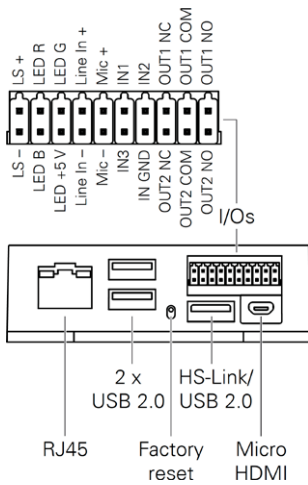

Quality tested. Reliable. Smart.

COMMEND products are developed and manufactured by Commend International in Salzburg, Austria.

The development and manufacturing processes are certified in accordance with **EN ISO 9001:2015**.



The technical data contained herein has been provided solely for informational purposes and is not legally binding. Subject to change, technical or otherwise. lolP®, OpenDuplex® and Commend® are trademarks registered by Commend International GmbH. All other brands or product names are trademarks or registered trademarks of the respective owner and have not been specifically earmarked.

Inputs

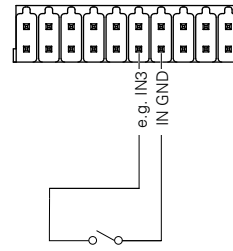

NOTE

It is possible to connect multiple buttons to one input. For further information, see product manual.

RGB-LED

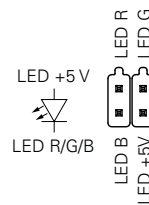

NOTE

The internal serial resistance of the RGB connections is 100 Ω .

A strong worldwide network

COMMEND is represented all over the world by local Commend Partners and helps to improve security and communication with tailored Intercom solutions.

www.commend.com